

Input Module

Preliminary



The Vemcon input modules are compact and stackable modules for distributed control systems.

At a glance / USP

- Compact dimensions and robust construction especially for heavy-duty use
- Suitable for safety critical application (ISO13849: PL_c and PL_d)
- 20 analog inputs
- 4 quadrature inputs
- Robust, wide-range power supply
- Optional 6 axis IMU

Technical data – electrical ratings

General data	
Supply voltage range	9...35 V
Effective integrated data processor	32 bit 48 MHz ARM Cortex-M0
Input voltage range	0 - 6.6 V
CAN Bus	Up to 1 MBit/s
Quadrature input	100 kHz
Inverse polarity protection	Yes
Current consumption (typical)	30 mA at 12 V
Input delay	5 ms
Input resistance	
Analog	22 kOhm
Quadrature	10 kOhm

Technical data – mechanical ratings

Temperature range	-35 °C - + 80 °C
Dimensions	96x82x23 mm
Weight	
Hermetically sealed (IP67)	
Connector	2x DTM04-12

Input Module

Preliminary

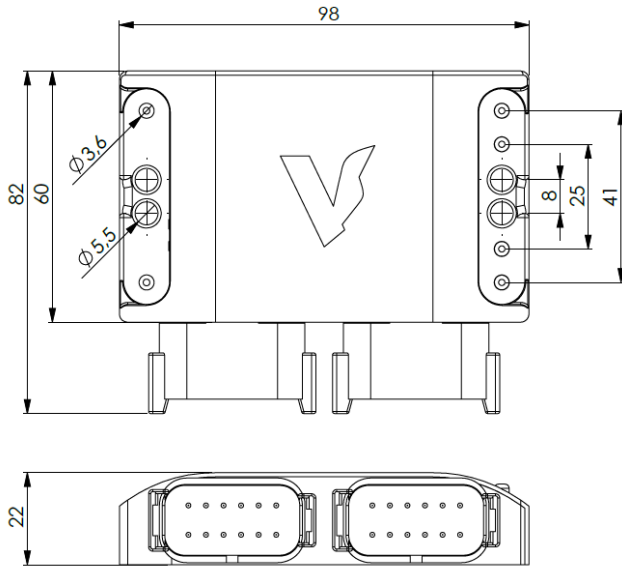





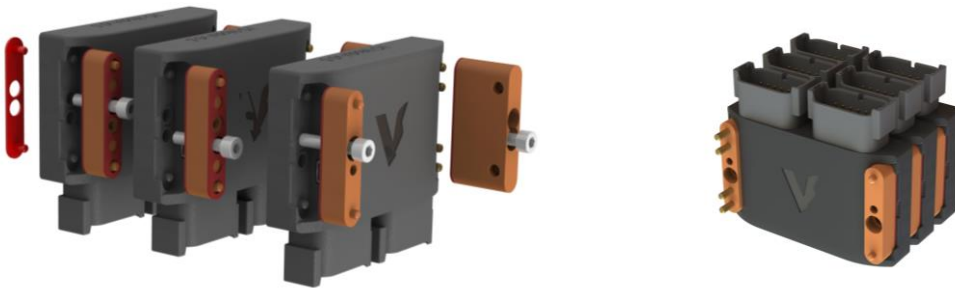

CAN-Protocol – J1939

CAN-Baudrate	250 kBaud
Interval Between Cycles	50 ms
Default source address:	0xE2

See also: IMU J1939 Specification document.
More/Customer-specific CAN protocols on request.

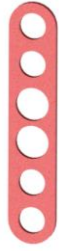
Can be stacked and combined with more I/O modules.



				
Blind seal 80467	Seal 80466	Assembly - end element 80461	Assembly – connection element 80464	Connection element 80465

Design is subject to modifications. Errors and omissions may occur.

Input Module

Preliminary

PIN functions Input Module

Key DTM04-12PA

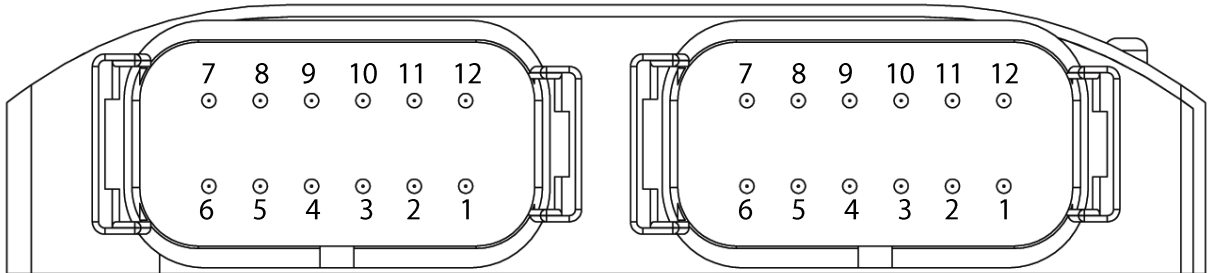

PIN	Function
1	5 V Out max. 200 mA
2	Analog IN6.1 /Quad. 3 A
3	Analog IN 7.1
4	Analog IN 8.1
5	Analog IN 9.1
6	Analog IN 10.1
7	Analog IN 10.2
8	Analog IN 9.2
9	Analog IN 8.2/Quad. 4A
10	Analog IN 7.2/Quad. 4B
11	Analog IN 6.2 /Quad. 3B
12	GND

PIN	Function
1	5 V Out max. 200 mA
2	Analog IN1.1 /Quad. 1 A
3	Analog IN 2.1
4	Analog IN 3.1
5	Analog IN 4.1
6	Analog IN 5.1
7	Analog IN 5.2
8	Analog IN 4.2
9	Analog IN 3.2/Quad. 2A
10	Analog IN 2.2/Quad. 2B
11	Analog IN 1.2 /Quad. 1B
12	GND

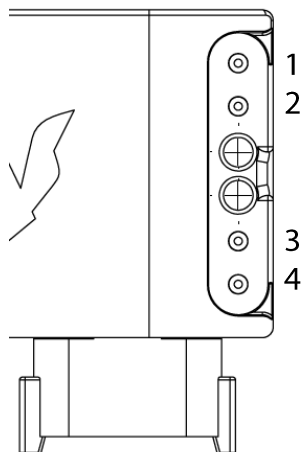

PIN	Function
1	+ 9-36 V
2	GND
3	CAN-Low
4	CAN-High

Design is subject to modifications. Errors and omissions may occur.



VEMCON

Machine Control.
Hands-On & Beyond.

Input Module

Preliminary

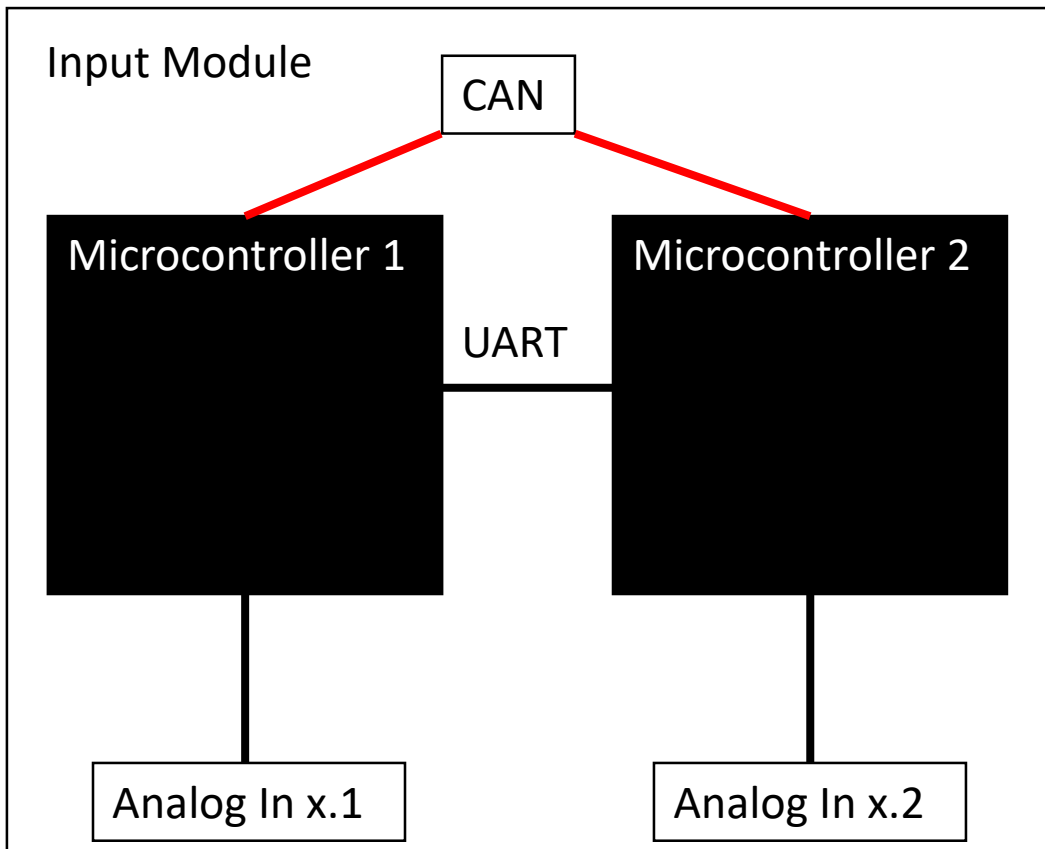

Design is subject to modifications. Errors and omissions may occur.